

# PRODUCT CATALOG FOR MEDICAL



# Mabuchi Motor's Solutions for Medical Applications

Mabuchi Motor is an electronic components manufacturer specializing in the development and production of small DC motors that are compact, lightweight, and highly efficient. Our products are deployed in a variety of applications including automobiles, healthcare, and home appliances. In the medical field, our products are used in various devices such as ventilations, surgical instruments, and electric injector, etc. In July 2021, we acquired Swiss company Electromag specializing in the development high-speed brushless DC motors for ventilations, dental handpieces, and orthopedic power tools. In March 2023, we incorporated Japanese company Oken Seiko, which has a high market share in rolling pumps for blood pressure monitors, to the Mabuchi Group to expand our portfolio for medical equipment. Characterized by our global development, production, and sales structure, we will contribute to the happiness of people around the world by offering optimal motors for medical equipment by combining the technologies cultivated by each company to date.

## Result in 2022 (Including multi use)

Production volume	Production bases	Sales offices
<b>1.3</b> Billion pcs	<b>17</b> Plants	<b>15</b> Offices

### Operating Room



### Patient room



### Home care



### Dental Clinic



#### High-Speed Brushless Motor

P06-P11

#### Orthopedic Power Tool

High-speed , Ultra-Quiet , Low vibration , Sterilizable



#### Ventilation

High-speed , Ultra-Quiet , Low vibration ,



#### CPAP

High-speed , Ultra-Quiet , Low vibration



#### Micromotors

High-speed , Ultra-Quiet , Low vibration

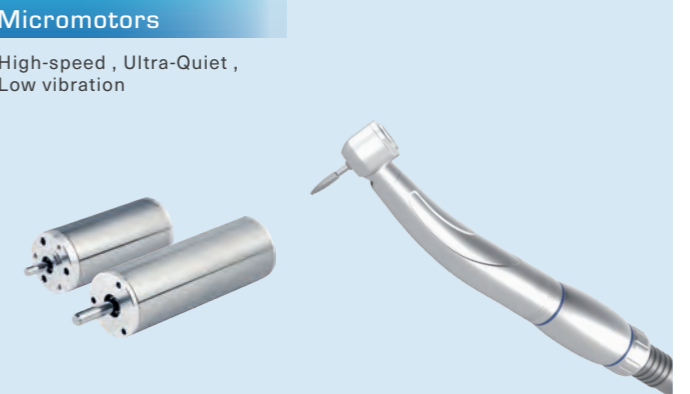

#### High-Power Brushless Motor

P12-P13

#### Frameless Brushless Motor

P14-P15

#### Medical Robotics

Low cogging



#### UV irradiation Robot

Compact, Lightweight, High efficiency



#### Oxygen Concentrator

Compact, Lightweight, High efficiency



#### Compact Brush Motor

P16-P17

#### Lavage Pump



#### Infusion Pump



#### Electric Injector



#### CAD/CAM

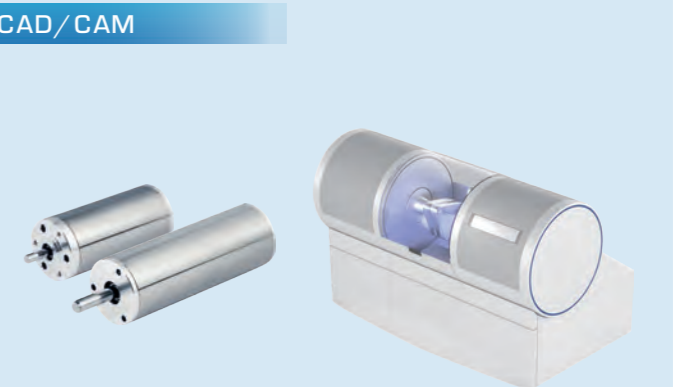

#### Rolling Pump

P18-P19

#### Patient Monitor



#### Blood Pressure Monitor



#### Nebulizer



# Product Lineup

## High-Speed Brushless Motor

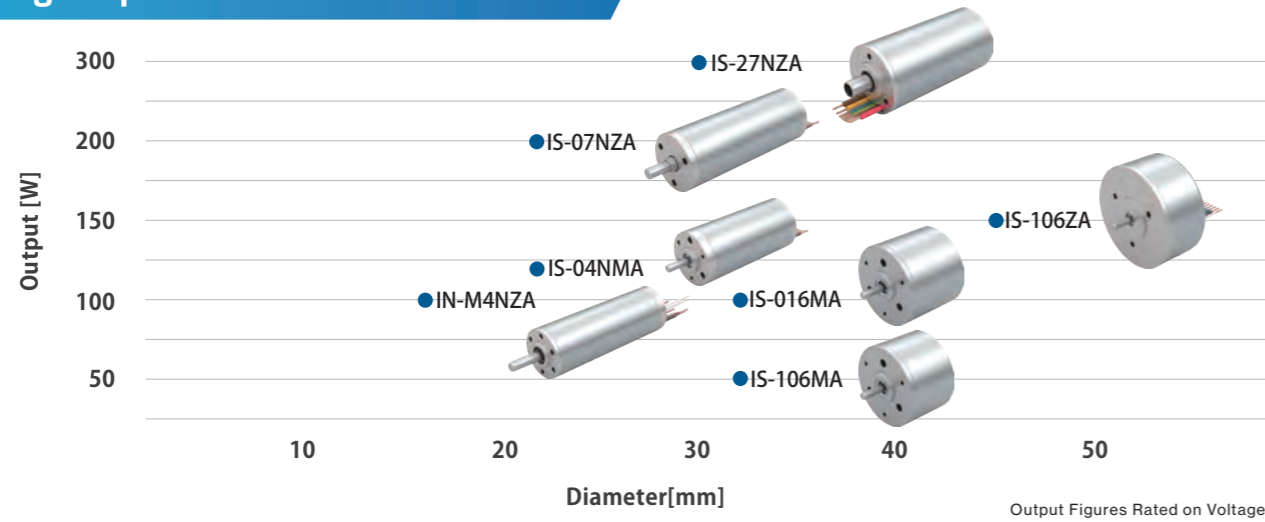

## Compact Brush Motor

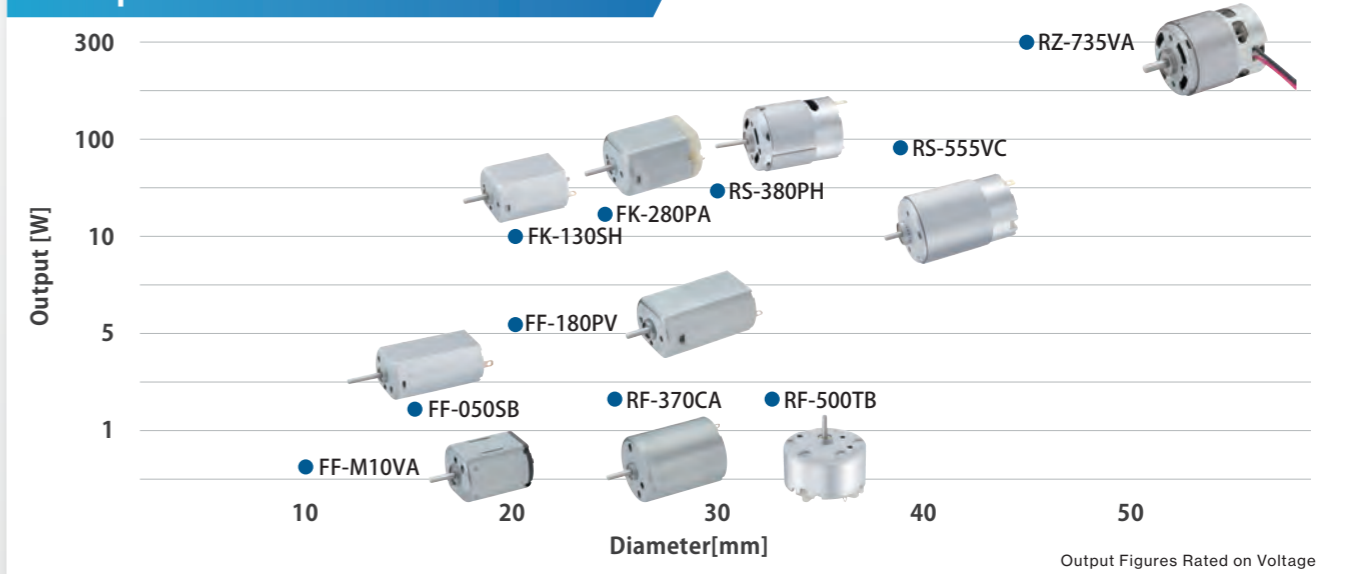

## High-Power Brushless Motor Frameless Brushless Motor

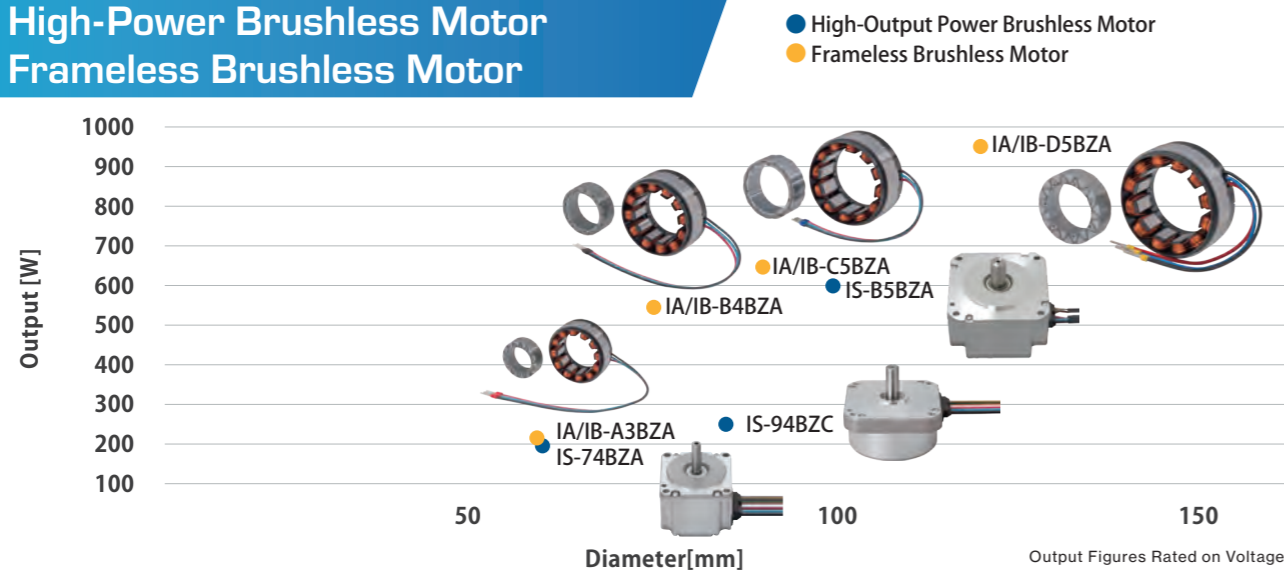

## Rolling Pump

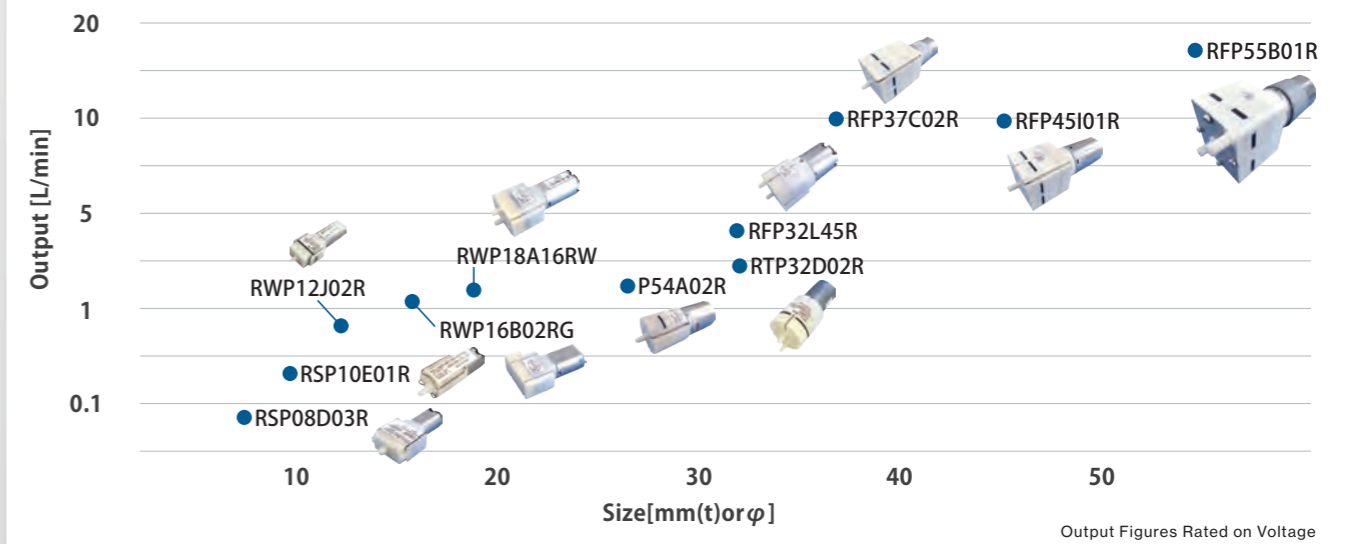

## Example of use

### High Speed Brushless Motor

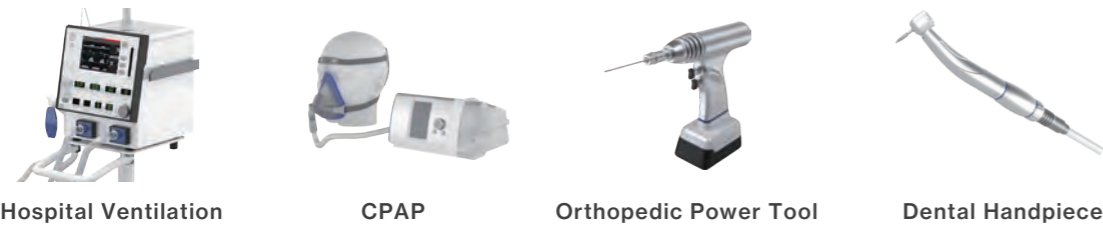

## Example of use

### Compact Brushed Motor

### Rolling Pump



For surgical applications, we offer a range of sterilizable 16, 22 and 30 mm motors integrating a patented coil technology that provides highest torque density. our motors feature a distinctive balancing process and a slotless design that eliminates cogging. The result: virtually no noise and vibrations for higher precision and user comfort. All motors are customizable allowing optimal integration.



Orthopedic Power Tool

Neurosurgery High speed Drill

ENT High Speed Drill



Model	IS-27NZA (30SLL1)	IS-07NZA (22SLL2)	IS-07NZA (22SLL1)	IS-M4NZA (16SLS1)
Size	Ø 30 x 60 mm	Ø 22 x 60 mm	Ø 22 x 60 mm	Ø 16 x 45 mm
Number of poles	2	4	2	2
Motor constant	21 mNm/√W	24.1 mNm/√W	13.2 mNm/√W	5.6 mNm/√W
Torque constant	Up to 12.0 mNm/A	Up to 17.3 mNm/A	Up to 8.8 mNm/A	Up to 6.8 mNm/A
Phase-phase resistance	0.03 – 0.33 Ohm	0.04 – 0.51 Ohm	0.04 – 0.51 Ohm	0.12 – 1.49 Ohm
No load speed	Up to 39,000 rpm @ 14.4 V	Up to 45,500 rpm @ 24 V	Up to 54,000 rpm @ 14.4V	Up to 87,000 rpm @ 18V
Max Output Power	Up to 313 W	Up to 217 W	Up to 217 W	Up to 88 W
Rated Torque	Up to 98 mNm	Up to 87 mNm	Up to 49 mNm	Up to 15 mNm
Max Speed at continuous drive	Up to 38,000 rpm @ 14.4 V	Up to 45,000 rpm @ 24 V	Up to 52,000 rpm @ 14.4 V	Up to 84,000 rpm @ 18 V
Torque at (Current)	Up to 361 mNm (30A)	Up to 519 mNm (30A)	Up to 265 mNm (30A)	Up to 68 mNm (10A)
Weight	200g	120g	120g	60g
Inner diameter of hollow shaft (Option)	5.45 mm	-	3.5 mm	-

IS-27NZA (30SLL1)

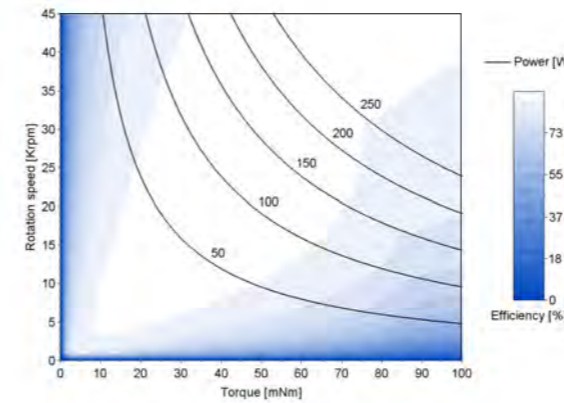
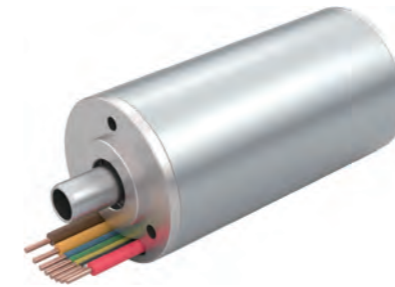

IS-07NZA (22SLL1)

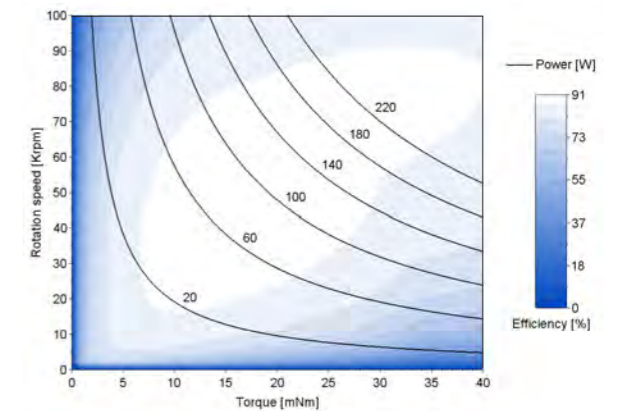

IS-07NZA (22SLL2)

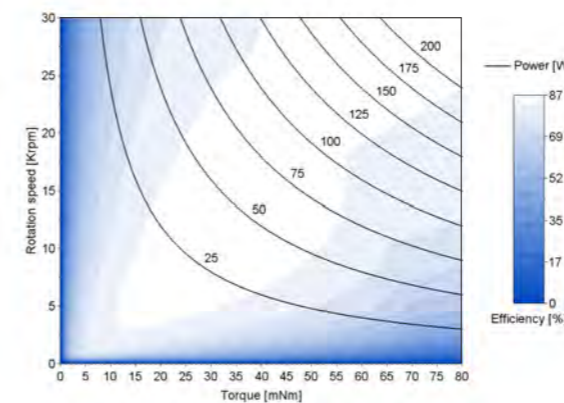

IS-M4NZA (16SLS1)

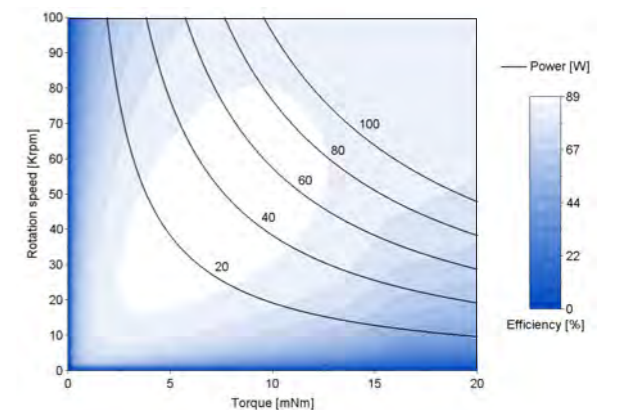

For implants and Micromotors, we offer a lineup of high-speed brushless motors with diameters of 16mm and 22mm. These products feature a patented coil design with higher torque density than conventional products. In addition, the slotless design provides quiet operation and low vibration at high speeds, making these motors ideal for use in high-precision, easy-to-use dental equipment. The interface with lead wire and terminals can be selected upon request.



- Implant
- Micromotors
- CAD/CAM

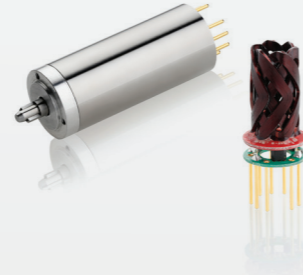

Model	IS-07NZA (22SLS1) Implant	IS-M4NZA (16SLS1) Micromotors
Size	Ø 22 x 45 mm	Ø 16 x 45 mm
Number of poles	2	2
Motor constant	8.6 mNm/√W	6.7 mNm/√W
Torque constant	7.7 mNm/A	4.0 mNm/A
Phase-phase resistance	0.8 Ohm	0.36 Ohm
No load speed	37,000 rpm @ 30.0 V	28,000 rpm @ 12 V
Max Output Power	37 W (30 V)	24 W (12 V)
	44 W (35 V)	48 W (27 V)
Momentary Maximum Torque	12.3 mNm (30 V)	8.7 mNm (12 V)
	10.1 mNm (35 V)	7.4 mNm (27 V)
Max Speed at continuous drive	27,300 rpm (30 V)	25,000 rpm (12 V)
	42,000 rpm (35 V)	62,000 rpm (27 V)
Torque at (Current)	38 mNm (5A)	16 mNm (4A)
Weight	88g	60g

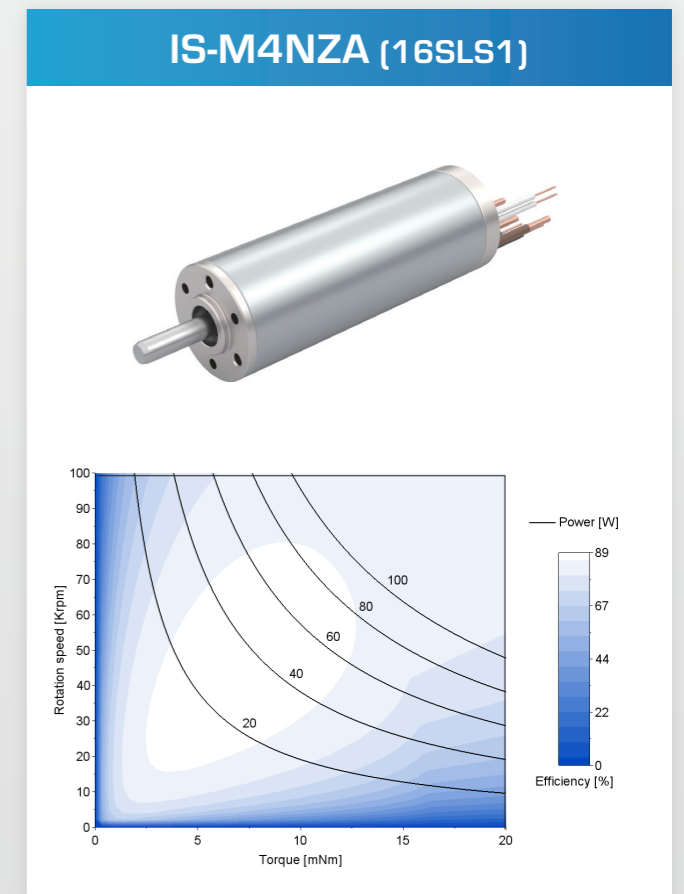
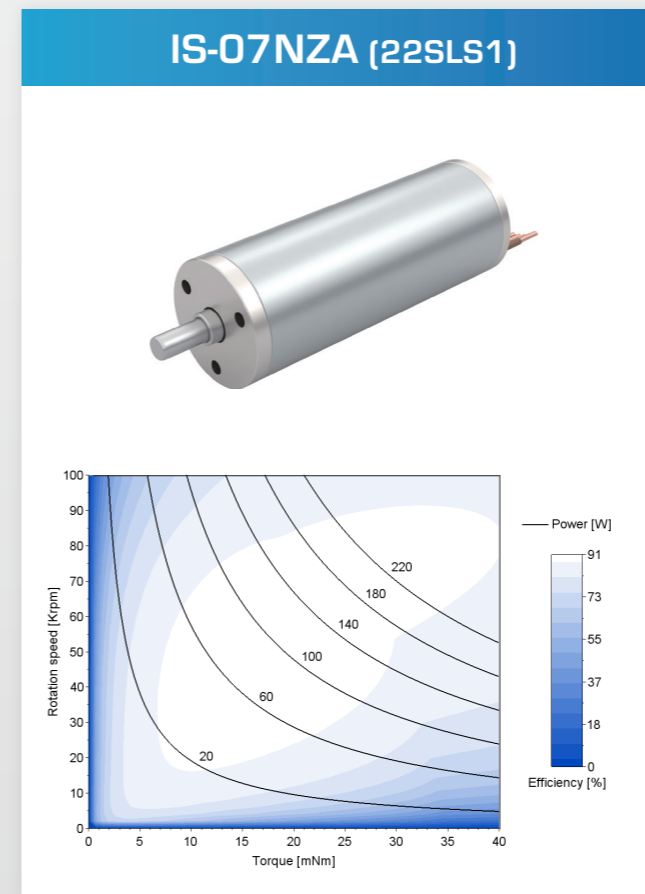







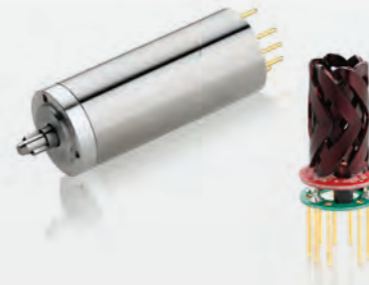

As a leading manufacturer of motors used in ventilators for emergency medical transportation, hospital, and home care applications, we offer a wide range of solutions to meet various blower pressure and flow characteristic requirements. Based on our experience and knowledge in this field, we offer motors that improve the performance of our customers' products, solve heat management problems, and save energy.

Our vibration control technology significantly reduces noise during motor operation, and our patented coil design achieves a maximum efficiency of 92%, which helps to improve the life of our customers' products. We also offer a full line of reasonably priced slotted motors for home care. We can also customize our motors to match the mechanical interface and electrical characteristics of your products.



- Ventilation
- High flow
- CPAP



Model	Size	Type	Motor Constant	Typical Speed Range				Power at Peak Efficiency				
				20	40	60	80	30	80	130	180	
IS-07NZA(22SLL1) 	Ø22 x 60 mm	slotless	11.8		40	60	80				130	180
IS-07NZA(22SLS1) 	Ø22 x 45 mm	slotless	8.6		40	60	80			80	130	
IS-M4NZA(16SLS1) 	Ø16 x 45 mm	slotless	6.7		40	60	80		30	80	130	
IS-106ZA(45STL1) 	Ø45 x 27 mm	slotted	12.2	20	40	60					130	180
IS-016MA(32STL1) 	Ø32 x 27 mm	slotted	6.0	20	40	60			30	80	130	
IS-106ZA(45STS1) 	Ø45 x 22 mm	slotted	6.4	20	40				30	80	130	
IS-106MA(32STS1) 	Ø32 x 22 mm	slotted	4.1	20	40	60			30			

Compact, lightweight, and high-efficiency brushless motor can be used in a wide range of applications, from autonomous robots and personal mobility devices to industrial and medical equipment, contributing to downsizing and energy saving.

Wheelchair

UV irradiation Robot

Surgical system



Model	IS-74BZA	IS-94BZC	IS-B5BZA
Instant Maximum Output	280W (10 sec max)	410W (10 sec max)	1,000W (10 sec max)
Instant Maximum Torque	0.9Nm (10 sec max)	2.0Nm (10 sec max)	4.0Nm (10 sec max)
Rated Voltage	24V		48V
Rated Output	200W	250W	600W
Rated Torque	0.6Nm	1.0Nm	2.3Nm
Rated Speed	3,200r/min	2,400r/min	2660r/min
Operating Voltage	15-55V		
Size	60.0mm × 60.0mm × length:44.5mm	85.0mm × 85.0mm × length:45.5mm	100.0mm × 100.0mm × length:54.0mm
Weight	520g	830g	1,750g
Insulation Voltage	500 V AC 1 minute (between terminal and case)		
Insulation Resistance	10 MΩ (min.) (500 V DC)		

The waterproof performance equivalent to IPX4 ensures safe use even in applications where water splashing may occur. Gear reducers (reduction ratios of 10 and 20), electromagnetic brakes, brackets, wheels, and dedicated controllers are available as optional items. Controllers has low radiated noise characteristics in accordance with CISPR32 Class B, eliminating the need for special electrical noise countermeasures by the customer.

## IS-94BZC

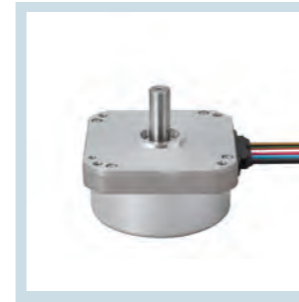

Brushless DC motor  
Equipped with hall sensors and thermistor  
IPX4 waterproof rating

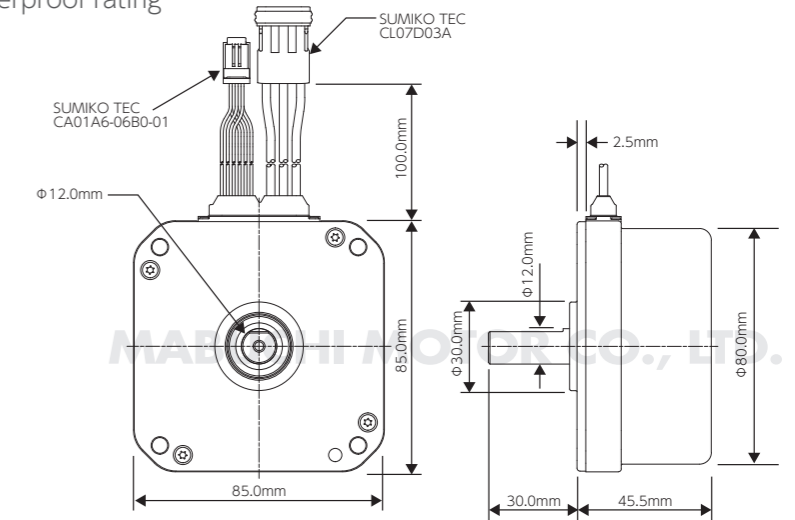
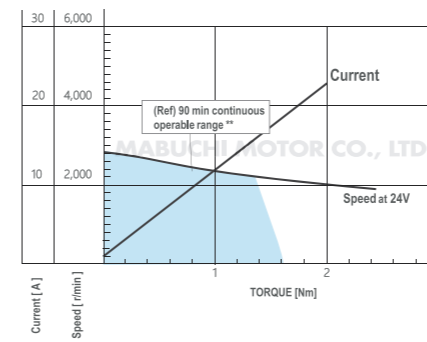

## IS-74BZA

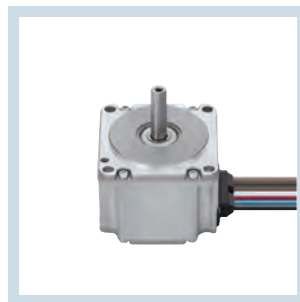

Brushless DC motor  
Equipped with hall sensors and thermistor  
IPX4 waterproof rating

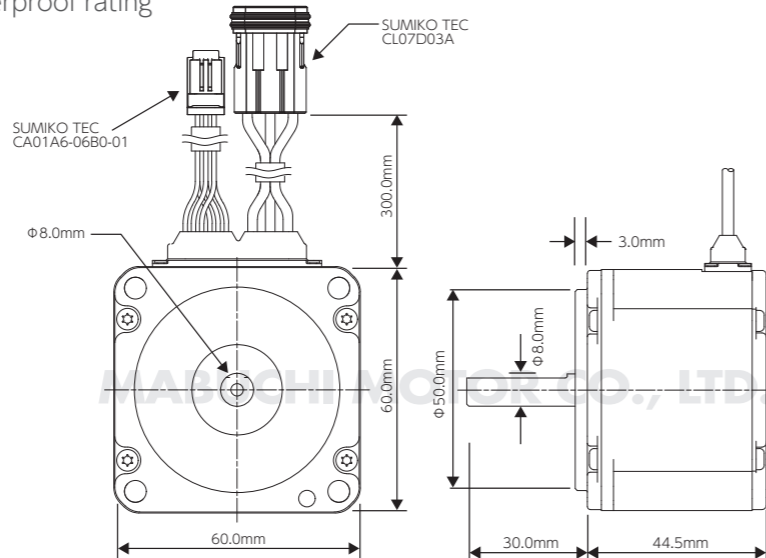
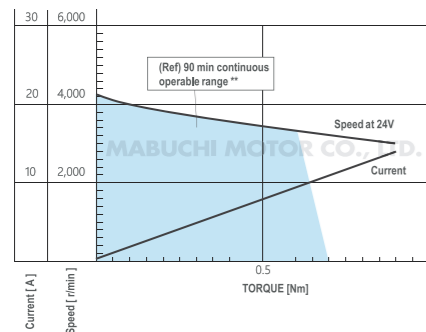

## IS-B5BZA



Brushless DC motor  
Equipped with hall sensors and thermistor  
IPX4 waterproof rating

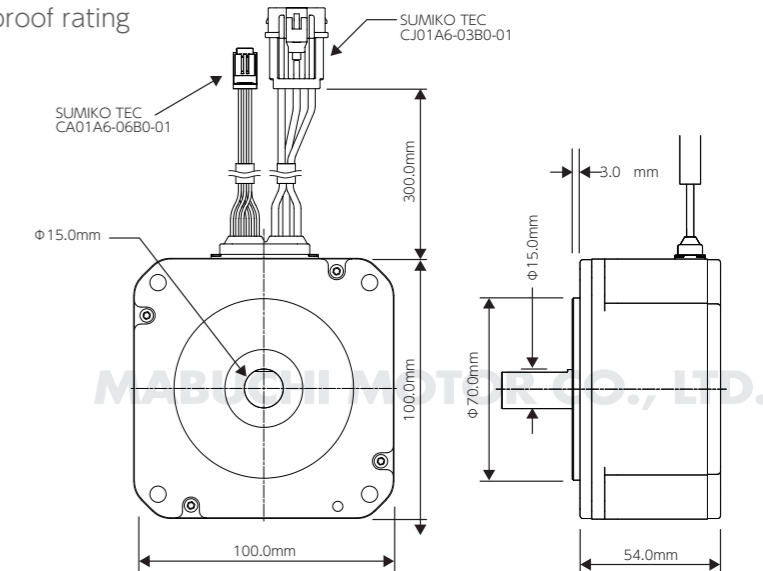
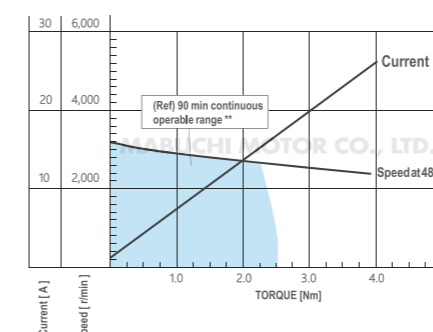

Frameless hollow-bore motor with low cogging design consisting of a stator and a rotor, designed for use in collaborative robots and products with built-in structures. This series is available in four different outputs and sizes.

## Medical Robot

### Suits a Wide Range of Applications

The motors, consisting of the rotor and stator, are available in four different outputs (200-960 W @48 V) and sizes (outer diameter of the stator, 60-120 mm).

### Energy Saving Design

Uniquely engineered magnetic circuit helps to sustain high energy efficiency over long operating periods.

### Smooth Movement

Low cogging for smooth motion.

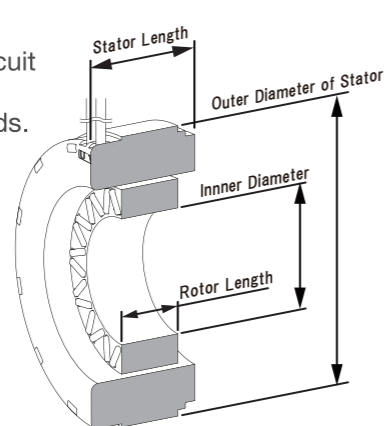

### Smaller, Lighter Products

The motor simply consists of the rotor and stator for easy installation and product downsizing.

Model	IA-A3BZA/IB-A3BZA	IA-B4BZA/IB-B4BZA	IA-C5BZA/IB-C5BZA	IA-D5BZA/IB-D5BZA
Momentary Maximum Torque	0.9 Nm (5 sec max)	2.1 Nm (5 sec max)	5.0 Nm (5 sec max)	11.0 Nm (5 sec max)
Rated Voltage	48V			
Rated Output Power	200W	500W	650W	950W
Rated Torque	0.42Nm	0.9Nm	1.3Nm	3.4Nm
Rated Speed	4,600r/min	5,300r/min	4,800r/min	2,700r/min
Operating Voltage	15-55V			
Outer Diameter of Stator	Φ 60.0mm	Φ 75.0mm	Φ 90.0mm	Φ 120.0mm
Inner Diameter	Φ 26.0mm	Φ 35.0mm	Φ 48.0mm	Φ 55.0mm
Stator Length	25.0mm	32.0mm	39.65mm	45.1mm
Rotor Length	14.2mm	18.4mm	22.9mm	23.6mm
Weight	190g	360g	600g	1,350g
Insulation Voltage	500 V AC 1 minute (Between the Lead Line and Laminated Core Part)			
Insulation Resistance	10 MΩ (min.) (500 V DC)			

Rated output, torque, and speed differs depending on the heat dissipation of the customer's casing.

## IA-A3BZA / IB-A3BZA

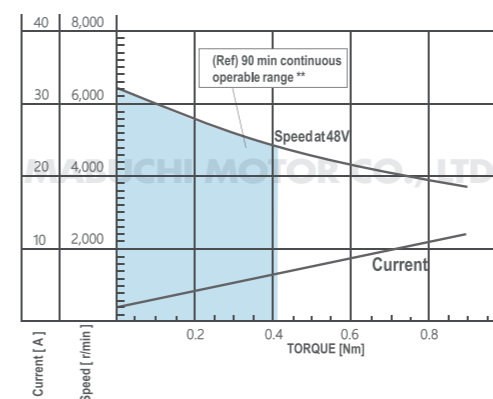

## IA-B4BZA / IB-B4BZA

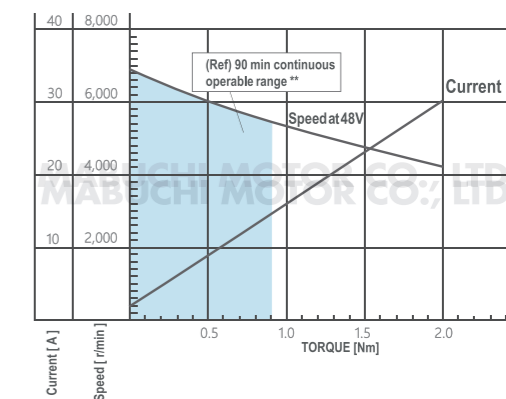

## IA-C5BZA / IB-C5BZA

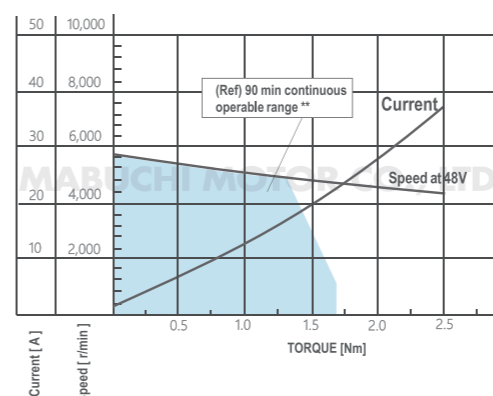

## IA-D5BZA / IB-D5BZA

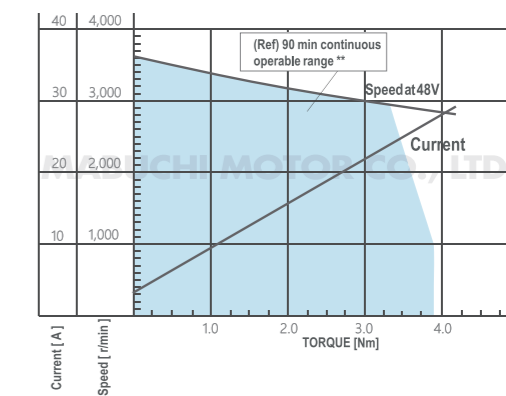
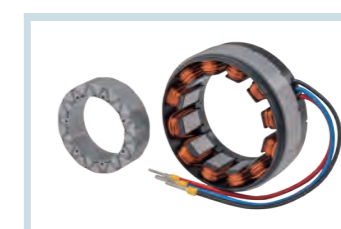

### Installation Notes:

- Shafts, bearings and other parts needed for mounting the motor are not included.
- Take precautions when installing the rotor into the stator to prevent contact with surrounding parts due to magnet attraction or repulsion.
- Set the rotor/stator coaxially and ensure the gap between the rotor and stator (stack) is per the criteria as shown.
- For more details, instruction manuals can be downloaded from Mabuchi website.

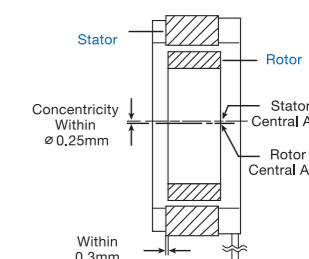



# Compact Brush Motor

As a pioneer of small brush motors, Mabuchi Group delivers its' motors in a wide variety of applications including automotive, life industry equipment, and medical equipment due to their high quality and reliability. With our extensive product lineup and global production system, we can provide a stable supply of high-quality motors at reasonable prices.

Lavage pump

Suction pump

Electric injector

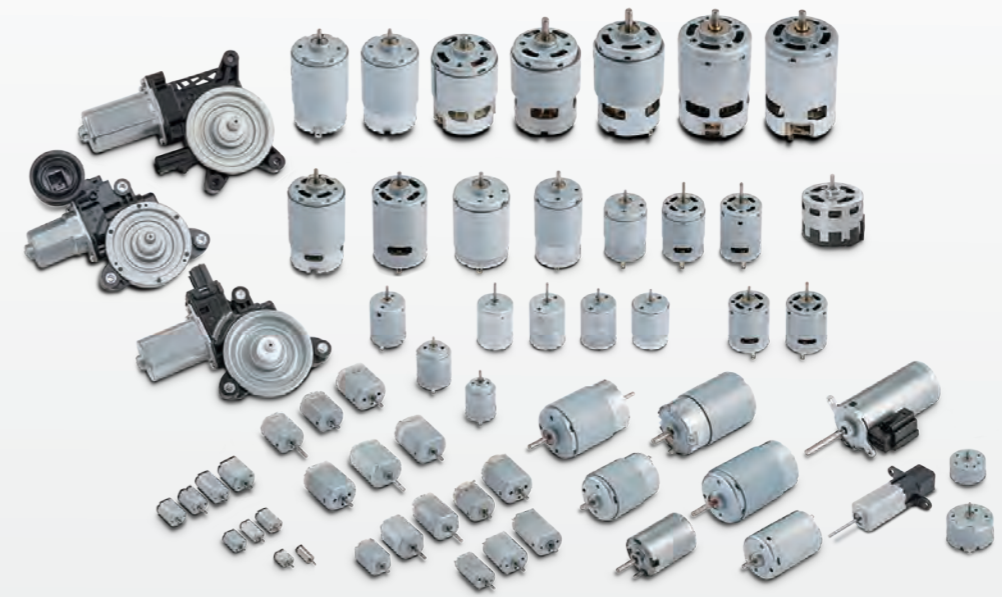

	FK-130SH	RS-380PH	RS-555VC	RZ-735VA
Operating Voltage (V)	5~24	3.6~24	7.2~24	12~24
Rated Speed (r/min)	4000~15000	3000~18000	4000~15000	4000~20000
Rated Output Power (W)	0.2~10	0.9~45	5~90	9~300
TYP.	Winding	09450	3270	3754
	Operation Voltage(V)	12	12	12
	Rated Torque (nNm)	0.981	9.81	39.2
	Rated Speed (r/min)	6050	13900	3450
Size (mm)	Φ20.4×15.4×25.1	Φ29.2×37.8	Φ38.5×57	Φ45×53.5
Weight (g)	24	82	250	280

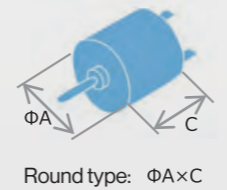
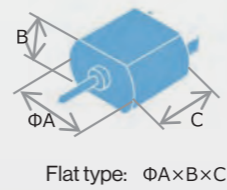

	FF-050SB	FF-180PV	RF-370CA	RF-500TB
Operating Voltage (V)	3~12	1.2~12	3~24	3~14
Rated Speed (r/min)	4000~10000	5000~10000	1500~8000	1000~6000
Rated Output Power (W)	0.2~1.5	0.05~5.6	0.6~2.0	0.01~2.0
TYP.	Winding	11170	2663	15370
	Operation Voltage(V)	7	3.6	12
	Rated Torque (nNm)	1.18	1.47	2.94
Rated Speed (r/min)	7550	8900	4500	
Size (mm)	Φ15.5×12×26.9	Φ20.4×15.4×32.1	Φ24.4×30.8	Φ32×19.5
Weight(g)	18	29	51	45

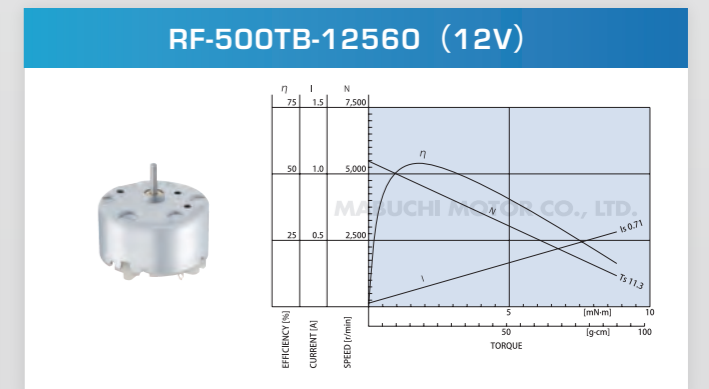
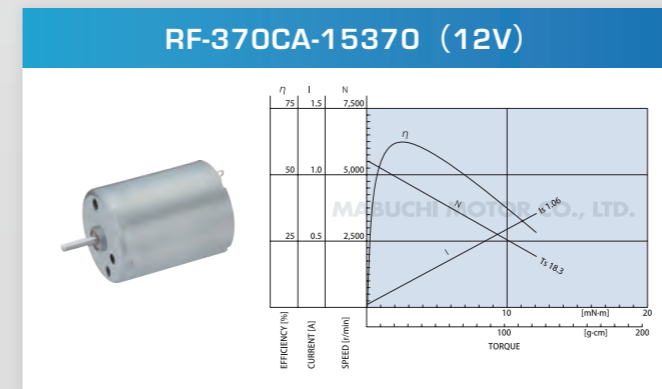
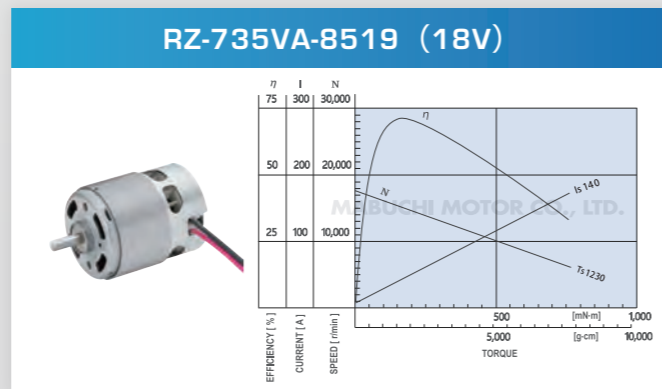
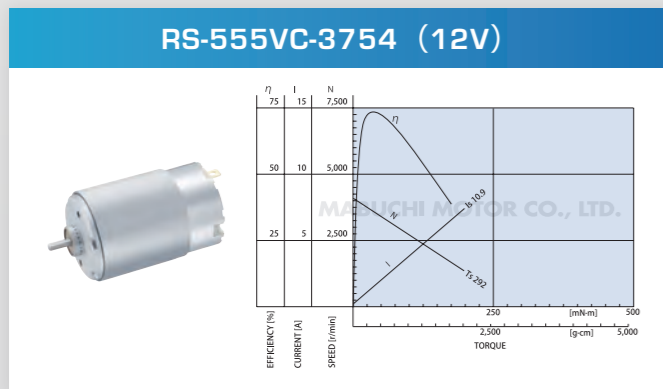
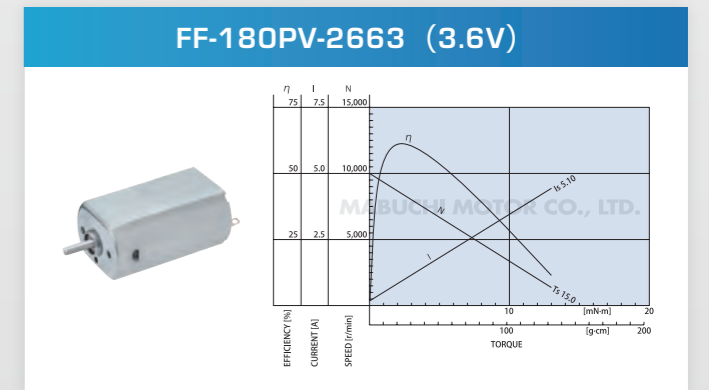
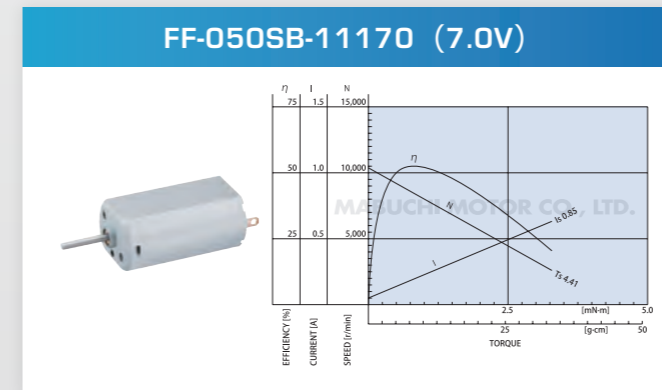
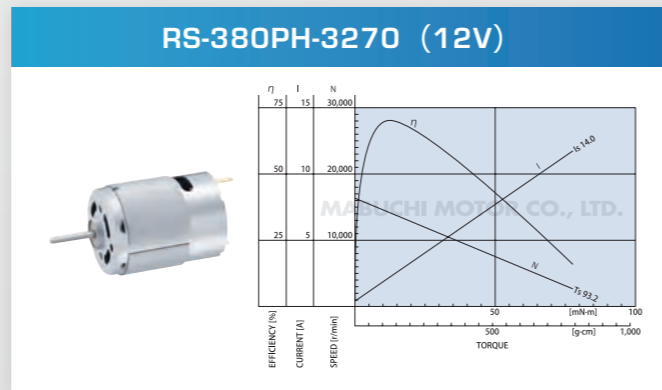
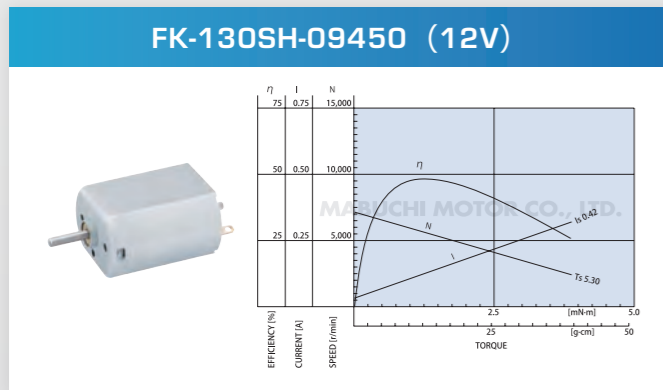
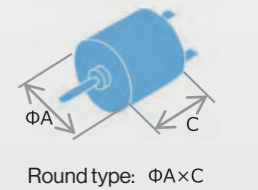
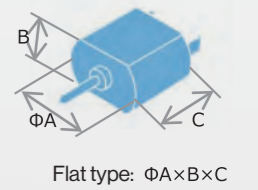

The implementation of multiple driven diaphragms enables to realize minimum-pulsation, quiet, long product-life, and the use of high-pressure pumps. We also offer a unique lineup of pumps, including pumps capable to supply a wide range of flow levels with only single unit using our unique patented valve, as well as pumps with an automatic exhaust release functions. Our stable supply of high-quality products has enabled us to become a preferred supplier for numerous leading medical customers.

Blood Pressure Monitor

Patient Monitor

Nebulizer



Model		RSP08D-01RW	P54A-0002R	P54C-0012RG	RFP32H-0001R
Item	Unit	Air Pump (positive pressure)	Air Pump (positive pressure)	Air Pump (positive pressure)	Air Pump (positive pressure)
Rated Voltage	VDC	2	6	6	12
Operating Voltage (V)	VDC	1.0~3.0	3.5~7.0	3.5~7.0	9.0~14.0
Free flow	L/min	0.08	2	2.4	4.4
No Load Current	mA	63	160	280	440
Max Current	mA	80	300	380	630
Max Pressure	kPa	68	100	90	140
Guaranteed Lifetime	hour	—	86	(170)	500
Operation Cycle for NIBP Usage *1	cyc	20k	30k	100k	—
Continuous operation with specific pressure *2	hour	—	—	—	500

\*1 RSP08D 01RW Pressurize 100ml tank up to 250mmHg, keep, exhaust and rest P54A 0002R and P54C 0012RG Pressurize 500ml tank up to 300mmHg, keep, exhaust and rest

\*2 Continuous operation with specific pressure

## RSP08D-01RW

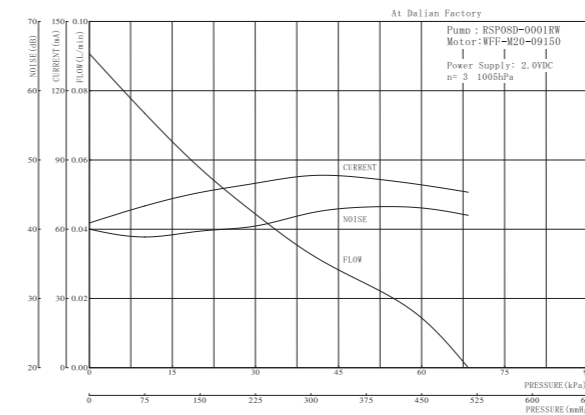

## P54A-02R

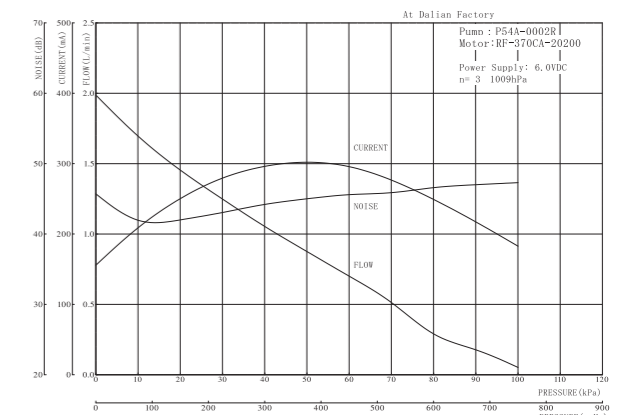

## P54C-12RG

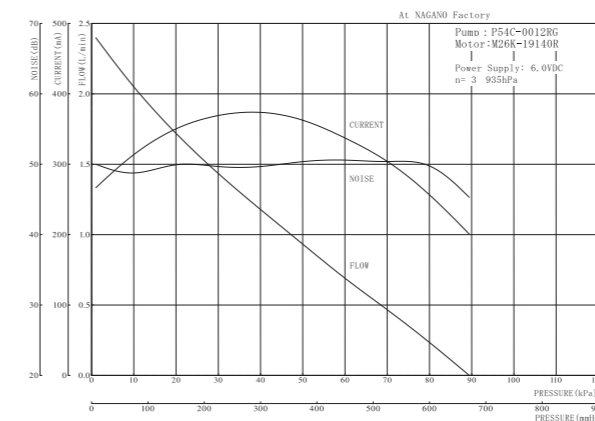

## RFP32H-01R

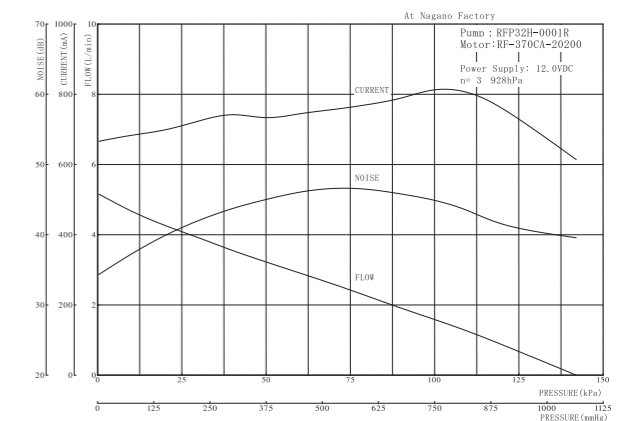

# WORLDWIDE NETWORK

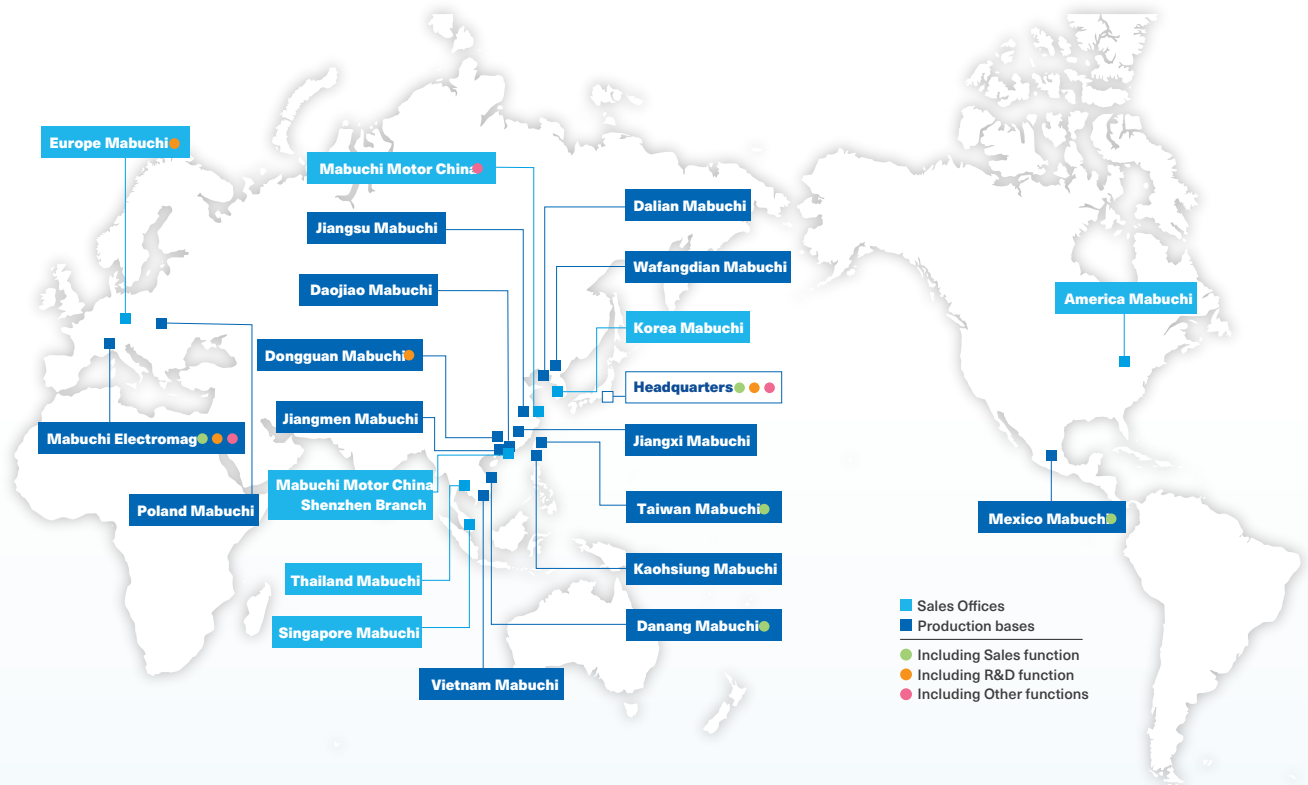

## MABUCHI MOTOR CO., LTD.

430 Matsuhidai, Matsudo City,  
Chiba 270-2280, Japan  
81-47-710-1868  
<https://www.mabuchi-motor.com/>

## MABUCHI MOTOR (EUROPE) GmbH

Herriotstrasse 1,  
60528 Frankfurt am Main, Germany  
49-69-6690220

## MABUCHI MOTOR (SHANGHAI) MANAGEMENT CO., LTD.

Room 1506-1510, Metro Plaza,  
No.555 Lou Shan Guan Road,  
Changning District, Shanghai, 200051 China  
86-21-6208-5666

## MABUCHI TAIWAN CO., LTD.

No.18, Chunghua Road, Hsinchu Industrial District,  
Hsinchu, 30352 Taiwan  
886-3-598-1111

## MABUCHI MOTOR DANANG LTD.

LotA2, No.3 street, Hoa Khanh Industrial Zone,  
Hoa Khanh Bac Ward, Lien Chieu District,  
Da Nang City, Vietnam  
84-236-3731931

## MABUCHI MOTOR (THAILAND) CO., LTD.

4345 Bhiraj Tower at BITEC, 12Fl., Unit 1201,  
Sukhumvit Road, South-Bangna Sub-district,  
Bangna District, Bangkok, 10260, Thailand  
66-2-091-0624

## MABUCHI MOTOR ELECTROMAG SA

Chemin du Dévent 7 Z.I. Larges Pièces A,  
1024 Ecublens, Switzerland  
41-21-694-1600  
<https://www.electromagmotor.com/>

## MABUCHI MOTOR AMERICA CORP.

3001 West Big Beaver Road,  
Suite 328, Troy, MI 48084 U.S.A.  
1-248-816-3100

## MABUCHI MOTOR (SHANGHAI) MANAGEMENT CO., LTD. SHENZHEN BRANCH

Unit 1601, Excellence Times Plaza, No.4068, Yitian Road,  
Futian District, Shenzhen City, Guangdong Province, 518017 China  
86-755-2399-8568

## MABUCHI MOTOR (SINGAPORE) PTE. LTD.

111, North Bridge Road,  
#21-02 Peninsula Plaza, Singapore 179098  
65-6339-9991

## MABUCHI MOTOR KOREA CO., LTD.

Ace High-End TowerIII 1403, 145,  
Gasam Digital 1-Ro, Geumcheon-Gu,  
Seoul, 08506 Korea  
82-2-534-8131

## MABUCHI MOTOR MEXICO S.A. DE. C.V.

Circuito Cerezos Oriente #105,  
Parque Industrial San Francisco IV,  
San Francisco De Los Romo, AGS 20355 Mexico  
52-449-478-3200